

United Knee System



Comprehensive Total Knee System –

The United Knee System is a comprehensive and organized total knee system designed to restore knee function throughout a full range of motion.

Based on the anatomy, kinematics, biomechanics, engineering and material technologies, the United Knee System offers fixed bearing, mobile bearing and revision prosthesis options to satisfy different patient needs.

Since the launch of the U2 Knee system in 2005, thousands of cases have been performed in over 39 countries around the world. The U2 Knee has demonstrated excellence in long-term clinical outcomes, with a survival rate of 97.7% at 10 years follow up^[1].

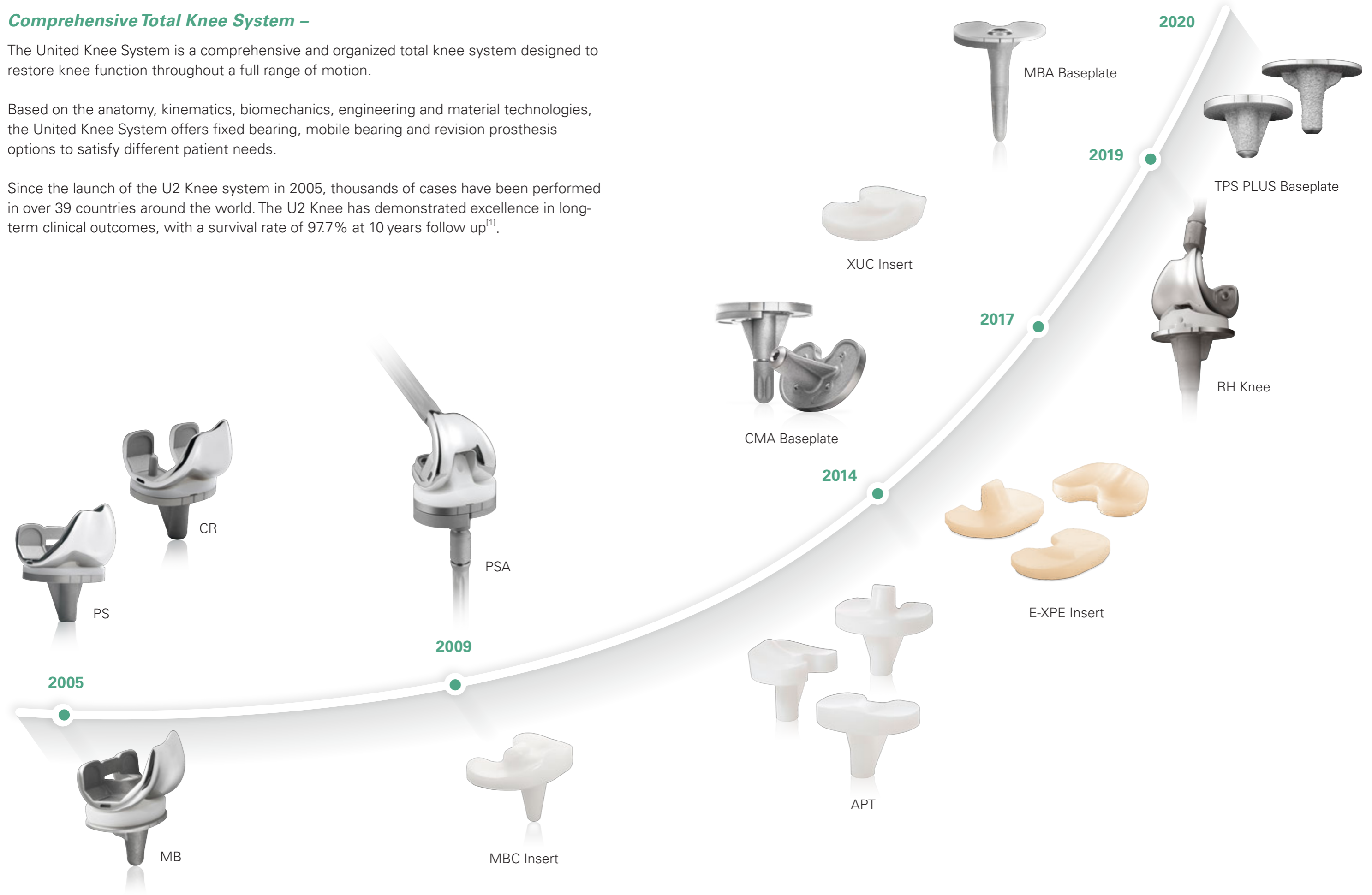

Consistency in U2 Knee System

Consistent condylar curvature and intercondylar width allows full interchangeability between femoral and tibial components.

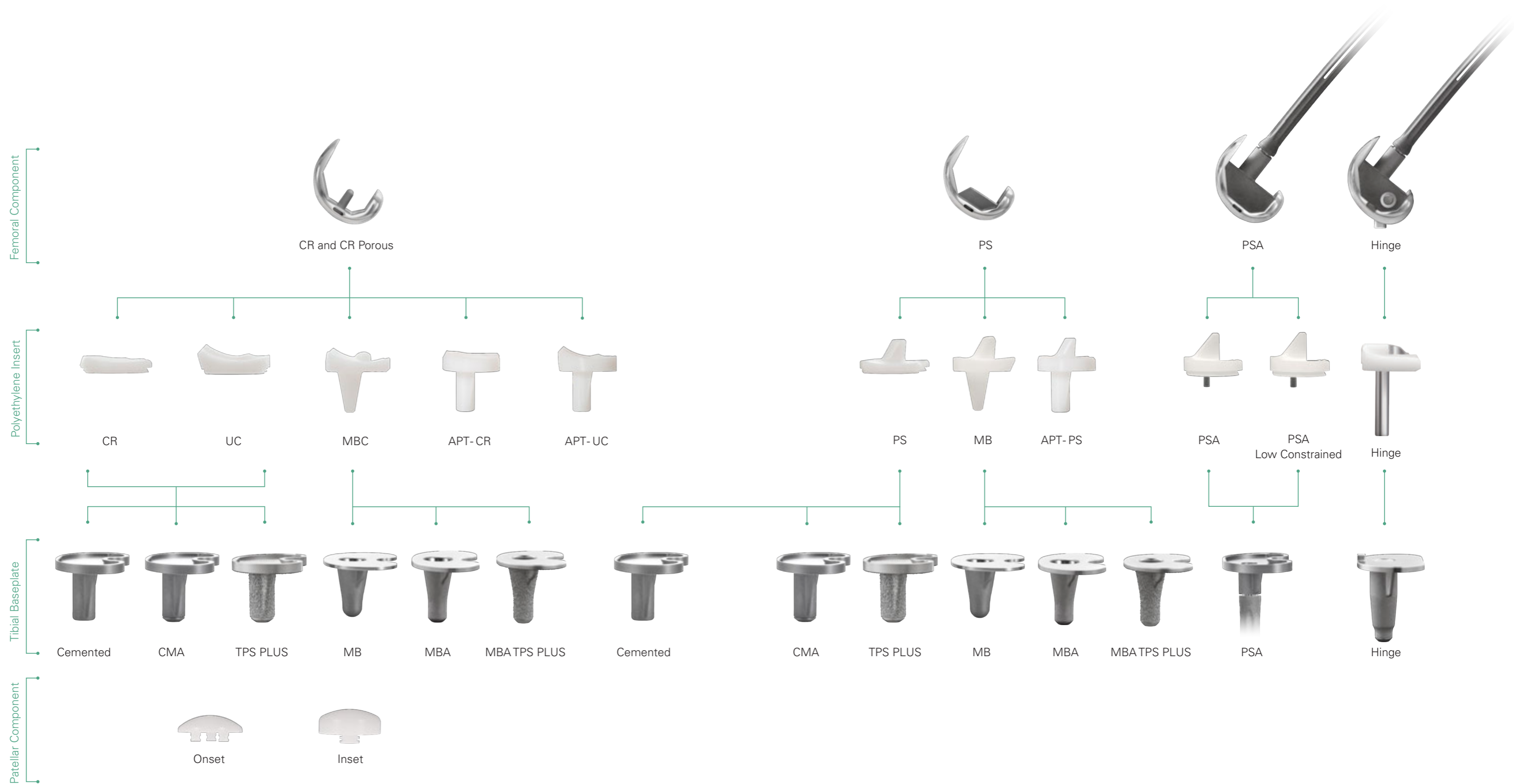

The PS (posterior stabilized) and CR (curciate retaining) femoral components have the same design features, including 2 mm A/P and M/L increments, extended patella groove, and consistent intercondylar width.

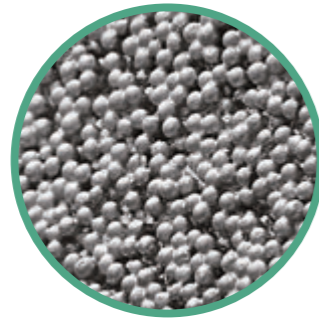

Two CR femoral component types are available
 - CR (Cemented type)
 - CR Porous (Sintered CoCr bead)

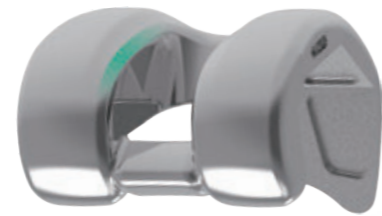

The extended patella groove is designed with increased contact area between the patella and femoral implants to allow for optimal patella tracking.

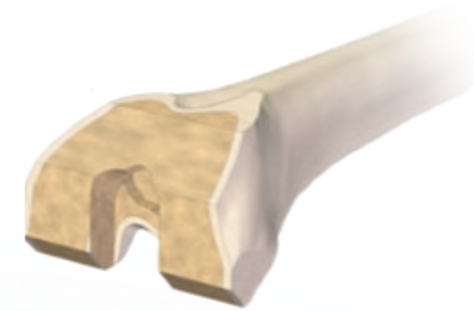

Smaller intercondylar bone removal together with rounded corners help avoid the risk of intercondylar fracture for PS box preparation.

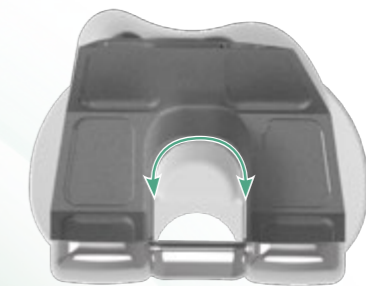

The curved anterior insert post and PS femoral cam is designed to reduce potential for impingement, component failure and poly wear.

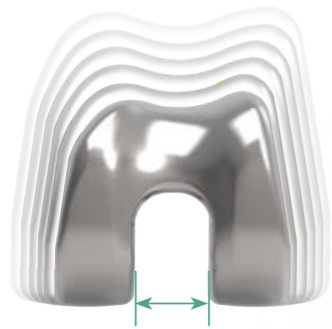

Consistent condylar curvature and standard intercondylar box width (in PS knee) allows full interchangeability between femoral and tibial components.



PS and CR femoral components are offered in 2 mm A/P and M/L increments to provide a comprehensive femoral sizing solution.



Within the fixed bearing design, three tibial baseplate options are available.

Cemented **M**odular **A**ugmentable (CMA)

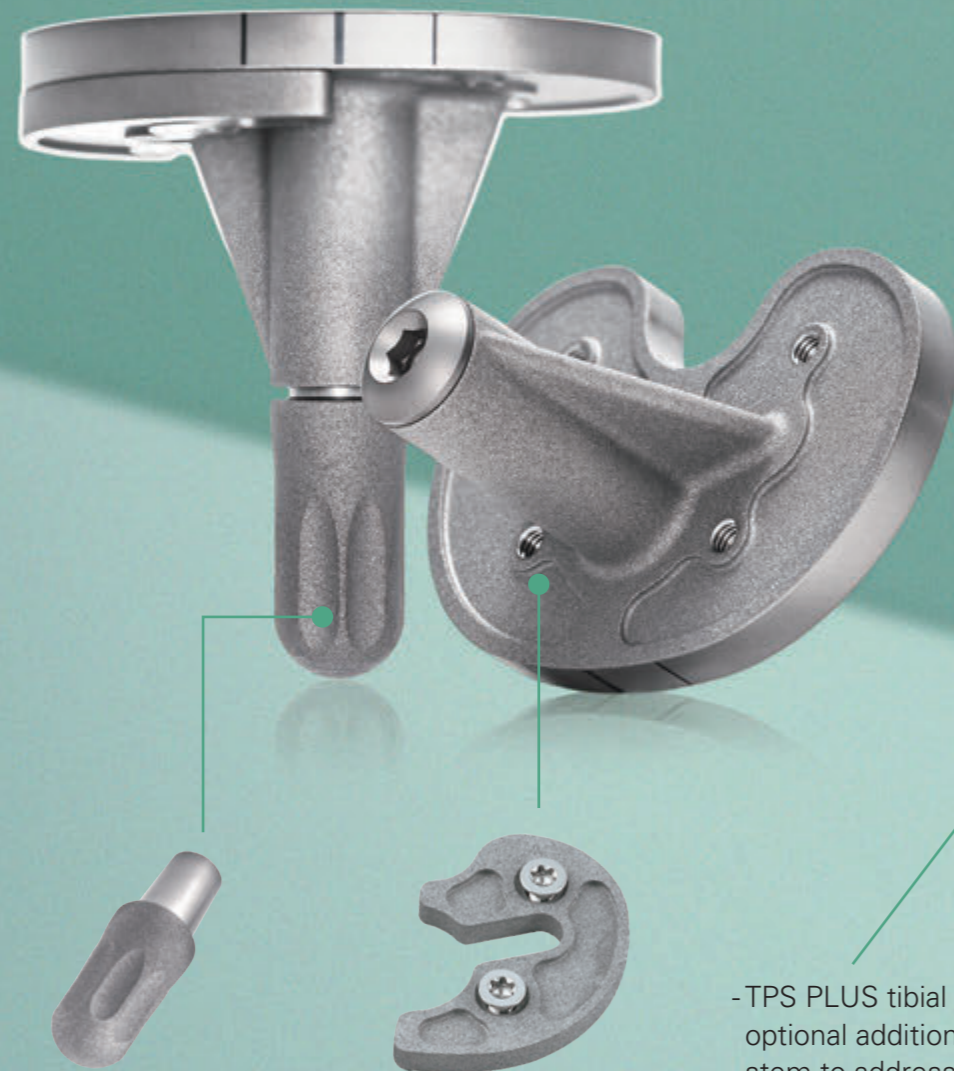

- CMA tibial baseplate allows the optional addition of 5 & 10 mm augments and 30 mm extension stem to address moderate tibial bone defects

Titanium **P**lasma **S**pray PLUS (TPS PLUS)

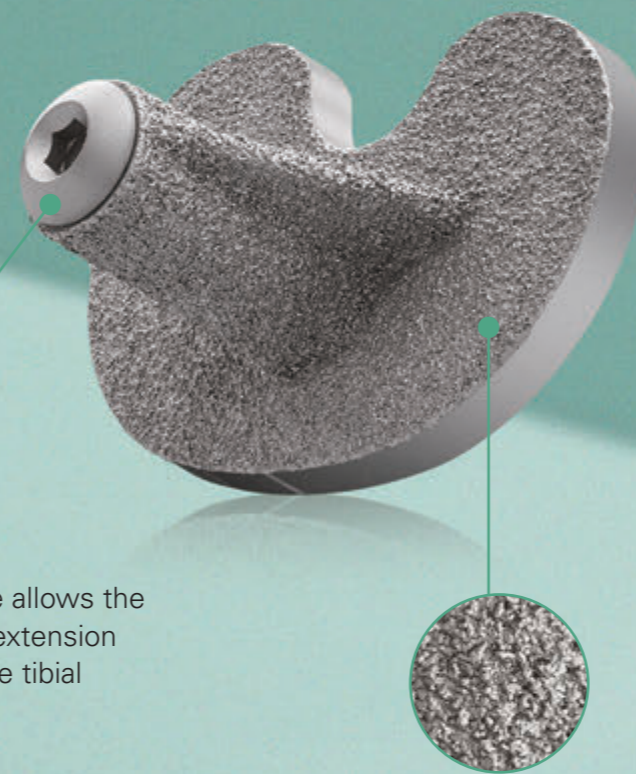

- TPS PLUS tibial baseplate allows the optional addition 30 mm extension stem to address moderate tibial bone defects

- Titanium Plasma Spray PLUS coating designed to improve biological fixation

Cemented



- Cemented tibial baseplate with rough surface and cement recess to promote optimal cement fixation

PS and CR Inserts

5° posterior slope built into CR and PS tibial inserts for horizontal tibial resection.

All CR, PS, UC inserts are available in UHMWPE (Ultra High Molecular Weight Polyethylene), XPE (Highly Crosslinked Polyethylene) , E-XPE (Vitamin E Highly Crosslinked Polyethylene).



UC Insert

Ultracongruent Design

- Accommodates CR femoral component
- The PCL sacrificing surgical technique allows for bone preservation and the potential for a less time consuming procedure
- Up to 14.5 mm prominent anterior lip and a more conforming articulating surface designed to provide joint stability



Tibial baseplate "one up / one down" size pairing for UC insert

Insert	Tibial Baseplate	Femoral													
		#1	#1.5	#2	#2.5	#3	#3.5	#4	#4.5	#5	#5.5	#6	#6.5	#7	
#0	#0	●													
#1	#1	●	●	●											
#2	#2	●	●	●	●	●									
#3	#3			●	●	●	●	●							
#4	#4					●	●	●	●	●					
#5	#5							●	●	●	●	●			
#6	#6									●	●	●	●	●	
#7	#7											●	●	●	

APT

All Poly Tibial Component

Durable, lower cost, elimination of backside wear, and designed for easier removal if necessary^[2,3].

Multiple articular selections: CR, PS, UC.

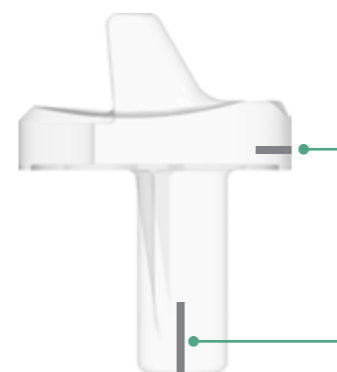

- Metal locating pin inside the APT component for X-ray image identification

- Deeper cement recess with rougher surface finishing to enhance cement fixation and anti-rotation

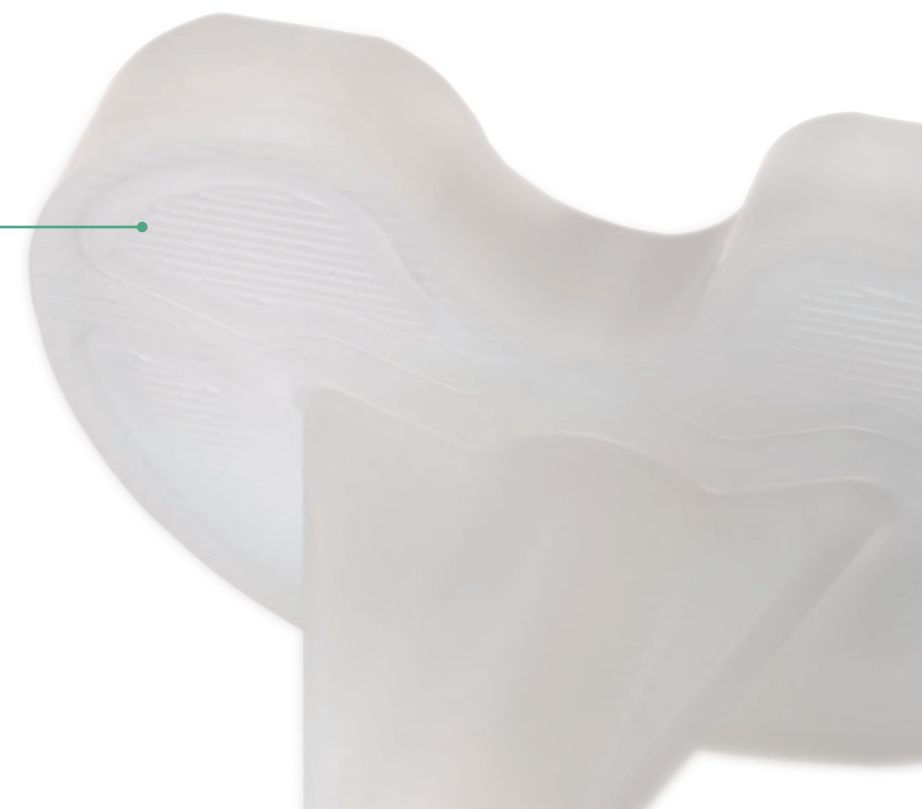

U2 MB™ Knee

Mobile Bearing Total Knee System

The Mobile Bearing rotating platform knee prosthesis provides both low contact pressure on the articular surface and low shear force on the bone-implant interface.



MBC, Mobile Bearing Congruent Insert

- For use with the U2 CR femoral component
- Surgery: PCL can be either retained or sacrificed
- Includes a central stopping mechanism designed to enhance Medial/Lateral (M/L) stability and also allows up to 4.5° hyper-extension



MB, Mobile Bearing Insert

- For use with the U2 PS femoral component
- Surgery: Both ACL and PCL sacrificed

Three Tibial Baseplate Options are Available Within the U2 MB Knee

- MB: Mobile bearing tibial baseplate
- MBA: Mobile bearing augmentable tibial baseplate
- MBA TPS PLUS: Mobile bearing augmentable Titanium Plasma Spray PLUS tibial baseplate



- Highly mirror-polished platform designed to reduce backside wear



Tibial Accessories Include

- 5 & 10 mm augments (MBA tibial baseplate only)
- Ø9 mm, lengths 20, 45, 70 and 95 mm extension stems
- Ø12.5 mm and 14 mm, length 45 mm extension stems

U2 PSA™ Knee

Revision Knee System

For use in the event of severe bone deficiency, as well as other complicated cases.

Can be used with augments and extension stem options to manage soft tissue and bone defects.

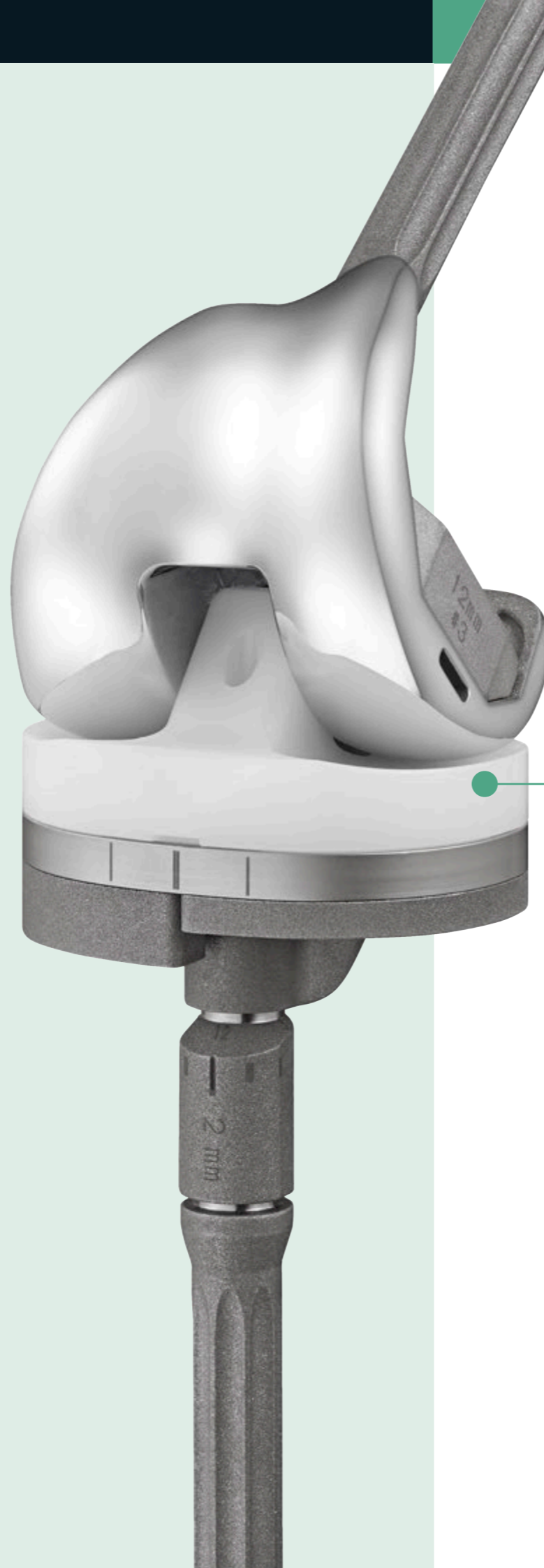

Two Insert Options in the U2 PSA Knee



PSA Insert



PSA LC (Low Constrained) Insert



Tibial Augment

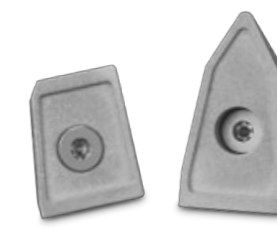

Femoral Augment



Improved Design for Optimal Function

- Constrained design with safety screw locking mechanism provides more secured stability

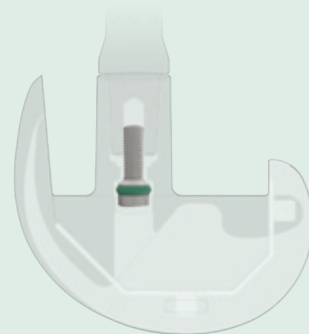

C Ring

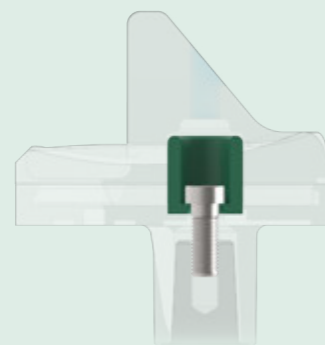

Reinforcement Bushing
Patent No. US 9044327

Multiple Extensions Choices

- Straight or curved extension stem length: 30 – 200 mm
- Distal femoral augment thicknesses : 4, 8, 12, 16 mm
- Posterior augment thicknesses: 4, 8 mm
- Tibial augment thicknesses: 5, 10, 15 mm
- 3 offset adapter selections with full range orientation: 2, 4, 6 mm

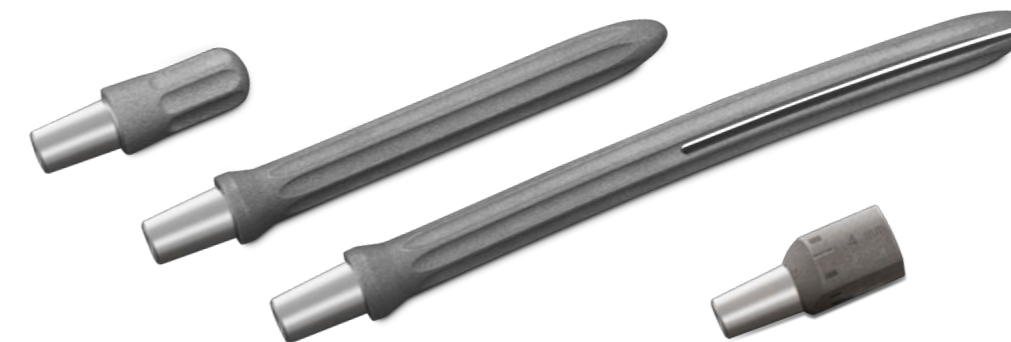

Extension Stem

Offset Adapter

USTAR II™

Rotating Hinge Knee System

An Extension to U2 Knee Family

- RH (Rotating Hinge) Knee is a rotating platform hinged knee prosthesis
- The resection design is the same with U2 primary and revision femoral components



U2 Primary



U2 PSA Revision



Hinge



Hinge Assembly



Femoral Accessories

Compatible with U2 PSA Revision Knee

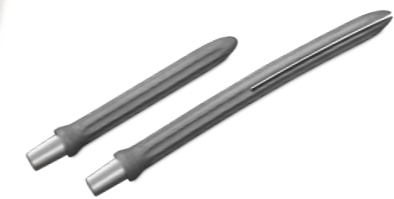

Press-fit Stem



Offset Adapter

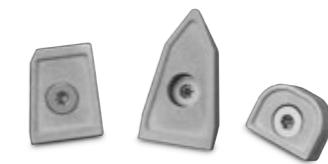

Femoral Augment



Femoral Screw

Tibial Accessories

Compatible with U2 MB Knee



Straight Stem

Hinge Knee only



Press-fit Stem



Tibial Augment



E-XPE

Vitamin E Highly Crosslinked Polyethylene

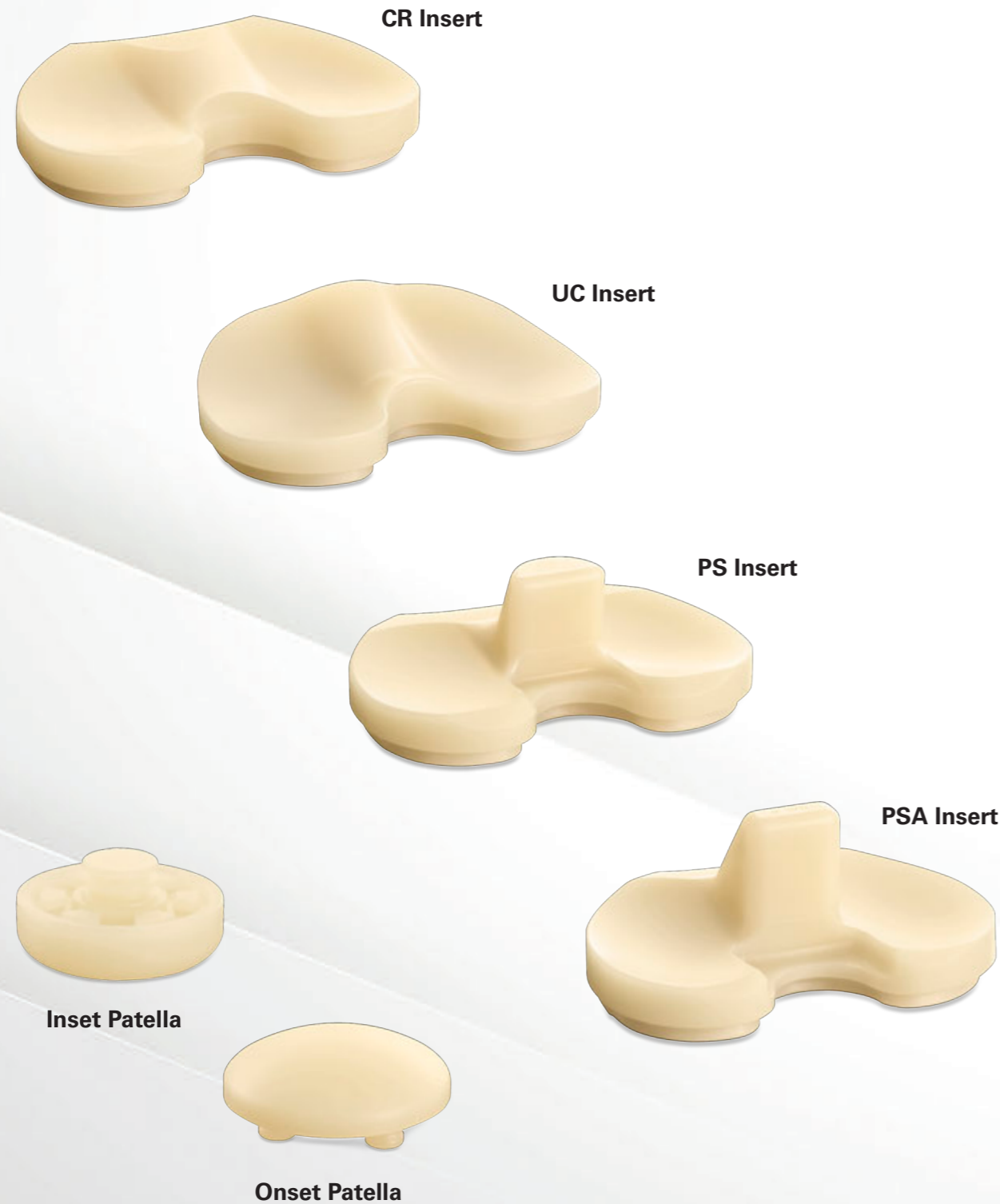

Advanced Bearing Technology

Wear Performance

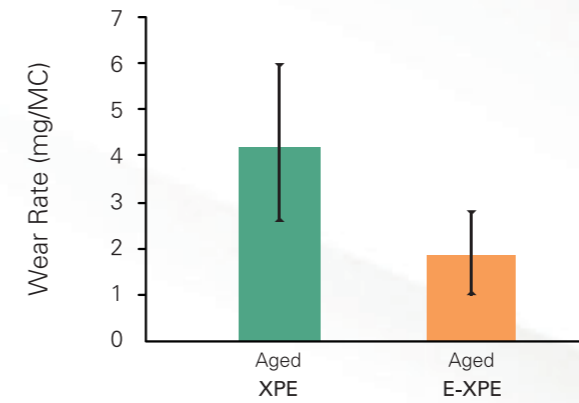

Extraordinary Wear Performance

E-XPE insert shows 60% reduction in gravimetric wear compared to XPE after accelerated aging^[4].

Mechanical Strength

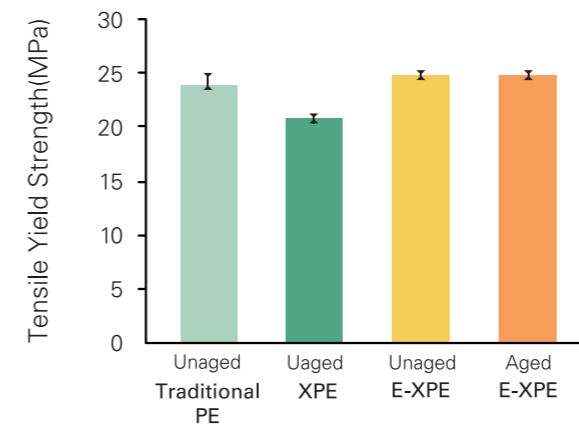

Enhanced Mechanical Strength

Heat treatment is not required after cross-linking process. Therefore, E-XPE shows a 20% tensile strength improvement as compared to highly cross-linked polyethylene^[5].

Oxidative Stability

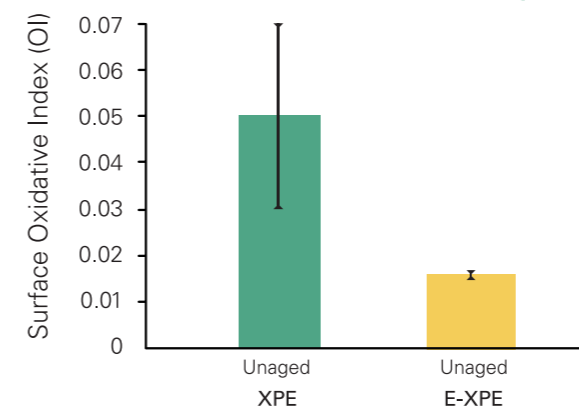

Superior Oxidative Stability

Surface oxidative index of E-XPE shows significant low oxidation after in vitro accelerated aging test^[6].

U2 Knee AiO™

All-in-One Sizing & Resection Block

Supports both anterior and posterior references.

Accommodates all 13 sizes of anterior and posterior femoral cuts in one block.

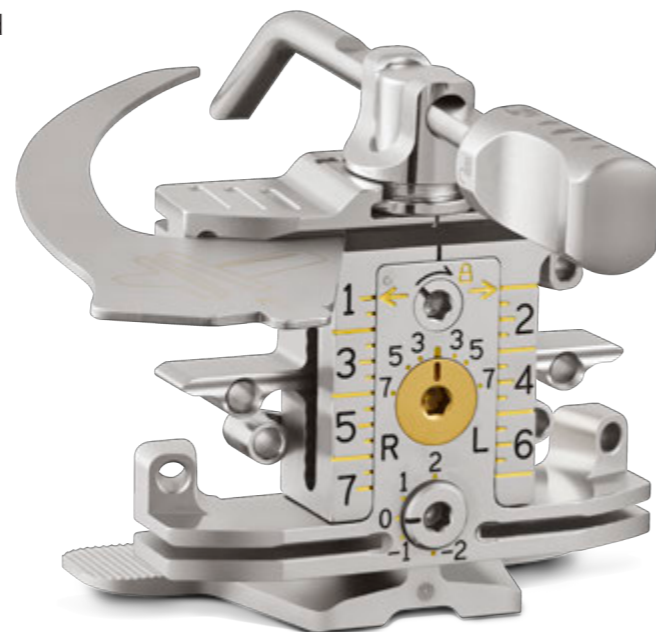

Patent No. US9974547

U2 Knee MDT™

Single-Use Modular Disposable Trial

Single-use trial set designed to reduce sterilization, reprocessing costs and infection risks.



20  19
BRONZE WINNER
MEDICAL DESIGN
EXCELLENCE AWARDS



When using the U2 Knee System's AiO Block and MDT Implant Trials together, the number of required instrument trays can be reduced from 6 to 1.5.

Implant

U2 Femoral Component

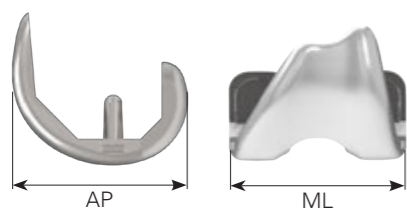

	#1	#1.5	#2	#2.5	#3	#3.5	#4	#4.5	#5	#5.5	#6	#6.5	#7
AP	52	54	56	58	60	62	64	66	68	70	72	74	76
ML	56	58	60	62	64	66	68	70	72	74	76	78	80

Unit : mm



Cemented CR & Porous CR

Sizes #1 ~ #7



PS

#1 ~ #7



PSA

#1 ~ #6



RH

XS, #1 ~ #6

U2 Tibial Baseplate

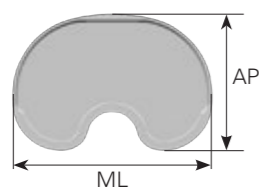

	#0	#1	#2	#3	#4	#5	#6	#7
AP	39.5	42	44.5	47	49.5	52.5	55.5	58.5
ML	60	63	66	69	72	76	80	84

Unit : mm



Cemented & CMA

Sizes #0 ~ #7



TPS PLUS

#0 ~ #7



MB & MBA

#1 ~ #6



TPS PLUS

#1 ~ #6



PSA

Sizes #1 ~ #6



RH

XS, #1 ~ #6

Implant

U2 Knee Fixed Bearing System



CR Cruciate Retaining

● UHMWPE ● XPE ● E-XPE



UC Ultracongruent

● XPE ● E-XPE



PS Posterior Stabilized

● UHMWPE ● XPE ● E-XPE

Thickness : 9 / 10 / 11 / 12 / 13 / 14 / 15 / 16 / 17 / 18 mm

U2 Knee Mobile Bearing System



MBC
Mobile Bearing Congruent

● UHMWPE ● XPE



MB
Mobile Bearing

● UHMWPE ● XPE



PSA
Posterior Stabilized Augmentable

● UHMWPE ● XPE ● E-XPE



PSA LC
PSA Low Constrained

● XPE

Thickness : 9 / 11 / 13 / 15 / 18 mm

Thickness : 9 / 11 / 13 / 15 / 18 / 21 / 25 / 30 mm

All Poly Tibial Component



CR Cruciate Retaining

● UHMWPE



PS Posterior Stabilized

● UHMWPE



UC Ultracongruent

● UHMWPE

Thickness : 9 / 11 / 13 / 15 / 18 mm

Hinge Knee Tibial Insert



● XPE

Thickness : 12 / 14 / 17 / 20 / 23 / 26 / 30 mm

Implant

Onset Patellar Component

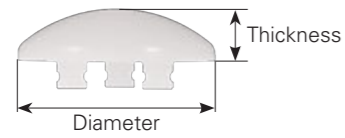

	XS	S	M	L	XL	XXL	EL
Thickness	7	8	8.5	9	9.5	10	10.5
Diameter	26	29	32	35	38	41	44

Unit : mm

● UHMWPE ● XPE ● E-XPE

Inset Patellar Component

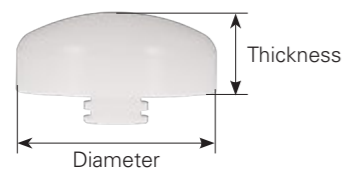

	S	M	L	XL
Thickness	8	10	10	10
Diameter	22	25	28	32

Unit : mm

● UHMWPE ● XPE ● E-XPE

Accessories

Fixed Bearing Knee



Tibial Augment

Thickness : 5 / 10 mm



Straight Stem

Length : 30 mm

Diameter : Ø14 mm

Mobile Bearing Knee



Tibial Augment

Thickness : 5 / 10 mm



Straight Stem

Length : 20 / 45 / 70 / 95 mm

Diameter : Ø9 mm



Press-fit Stem

Length : 45 mm

Diameter : Ø12.5 / 14 mm

PSA Revision Knee

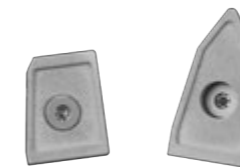

Distal Femoral Augment

Thickness : 4 / 8 mm 12 / 16 mm

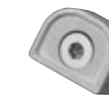

Posterior Femoral Augment

Thickness : 4 / 8 mm



Tibial Augment

Thickness : 5 / 10 / 15 mm



Straight Stem

Length : 30 / 75 / 100 / 150 / 200 mm

Diameter : Ø10 / 12 / 14 / 16 / 18 / 20 / 22 / 24 mm



Curved Stem

Length : 150 / 200 mm

Diameter : Ø10 / 12 / 14 / 16 / 18 / 20 / 22 / 24 mm



Offset Adapter

Offset : 2 / 4 / 6 mm

Accessories

USTAR II RH Knee

Femoral Part



Distal Femoral Augment

Posterior Femoral Augment

Thickness :	4 / 8 mm	12 / 16 mm	4 / 8 mm
-------------	----------	------------	----------



Straight Stem

Curved Stem

Offset Adapter

Length :	30 / 75 / 100 / 150 / 200 mm	150 / 200 mm	2 / 4 / 6 mm
----------	------------------------------	--------------	--------------

Diameter :	Ø10 / 12 / 14 / 16 / 18 / 20 / 22 / 24 mm	Ø10 / 12 / 14 / 16 / 18 / 20 / 22 / 24 mm	
------------	---	---	--

Tibial Part



Tibial Augment

Thickness :	5 / 10 / 15 mm
-------------	----------------



Straight Stem

Press-fit Stem

Length :	20 / 45 / 70 / 95 / 120 / 145 mm	45 / 70 / 95 / 120 mm
----------	----------------------------------	-----------------------

Diameter :	Ø9 mm	Ø12.5 / 14 mm
------------	-------	---------------

Reference

[1] Data held on file. United Orthopedic Corporation

[2] All-Polyethylene Versus Metal-Backed Tibial Components—An Analysis of 27,733 Cruciate-Retaining Total Knee Replacements from the Swedish Knee Arthroplasty Register. Asgeir Gudnason, Nils P. Hailer, Annette W-Dahl, Martin Sundberg, Otto Robertsson., J Bone Joint Surg Am. 2014

[3] The role of the cemented all-polyethylene tibial component in total knee replacement: a 30-year patient follow-up and review of the literature. Thomas J. Blumenfeld, Richard D. Scott., Knee. 2010

[4] Data held on file. United Orthopedic Corporation

[5] Data held on file. United Orthopedic Corporation

[6] Data held on file. United Orthopedic Corporation

Please note that all United Orthopedic Corporation product brochures have been authored in the English language. Any translations into other languages have not been reviewed or approved by United Orthopedic Corporation and their accuracy cannot be confirmed. Any questions regarding United Orthopedic Corporation products should be directed to United Orthopedic Corporation at unitedorthopedic.com/contact.

The CE mark is valid only if it is also printed on the product label.
Not all products are approved by CE or FDA, please contact with your United representative or local distributor for further information.



Importiert & vertrieben in der Schweiz durch
Importé & distribué en Suisse par
Importato e distribuito in Svizzera da

The logo for Plusortho Prothetik, featuring a stylized red 'P' followed by the text 'PLUSORTHO PROTHETIK' in a bold, sans-serif font.

Aeschwuhstrasse 54 info.ch@plusortho.ch
CH-4665 Oftringen tel +41(0)62 788 2010
www.plusortho.ch fax +41(0)62 788 2011

