

U-Motion II PLUS™ Cup

Acetabular Hip System



U-Motion II PLUS –

U-Motion II PLUS is a comprehensive acetabular hip system which offers a wide range of acetabular cup, liner and femoral head prostheses options for primary and revision hip arthroplasty.

U-Motion II PLUS utilizes a Titanium Plasma Spray PLUS (TPS PLUS) coating technology for increased roughness. TPS PLUS coating technology designed to provide outstanding bonding strength and 'scratch fit' for initial stability.

U-Motion II PLUS Acetabular System offers larger femoral head sizes designed to help restore hip mobility and reduce the risk of joint dislocation. The advanced acetabular system grants orthopedic surgeons flexibility during surgery for addressing clinical problems they might encounter.





Overview

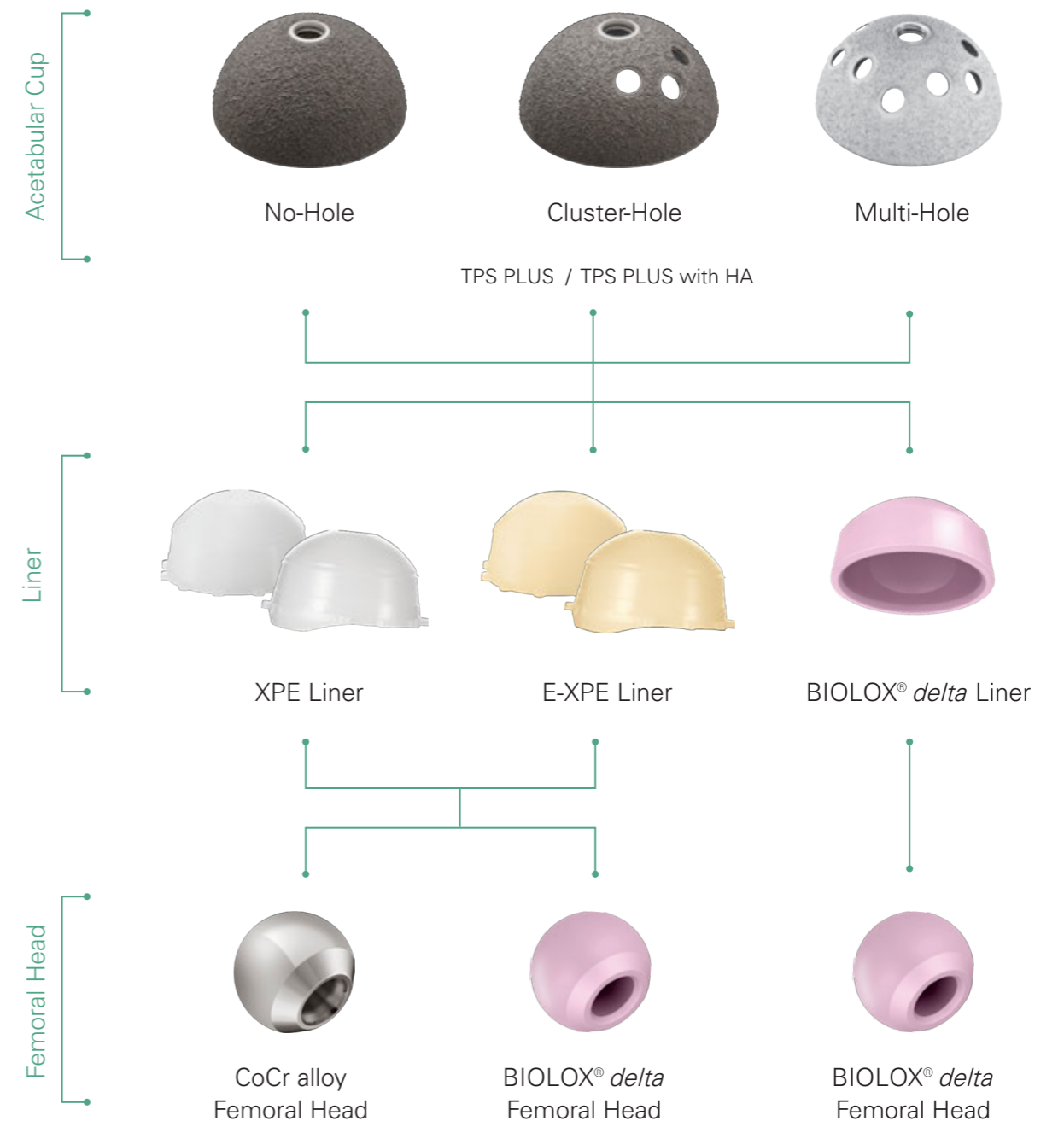

*BIOLOX® is a registered trademark of the CeramTec Group, Germany

U-Motion II PLUS™ Cup

TPS PLUS Surface Coating

U-Motion II PLUS System utilizes the Titanium Plasma Spray PLUS (TPS PLUS) coating technology to achieve a greater surface roughness (Ra).

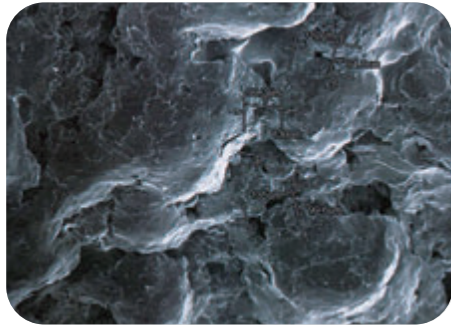

The coating of the implant was designed to help provide a scratch fit for initial stability and has been shown to reduce micromotion; both effects help contribute to long term fixation of the implant^[1,2].



U-Motion II PLUS Cup :
58 mm Cup has a 58.7 mm outer diameter



1 Increase Surface Roughness

2 Increasing Shear Strength

3 Increasing Initial Stability

4 Increasing Bone Osteointegration



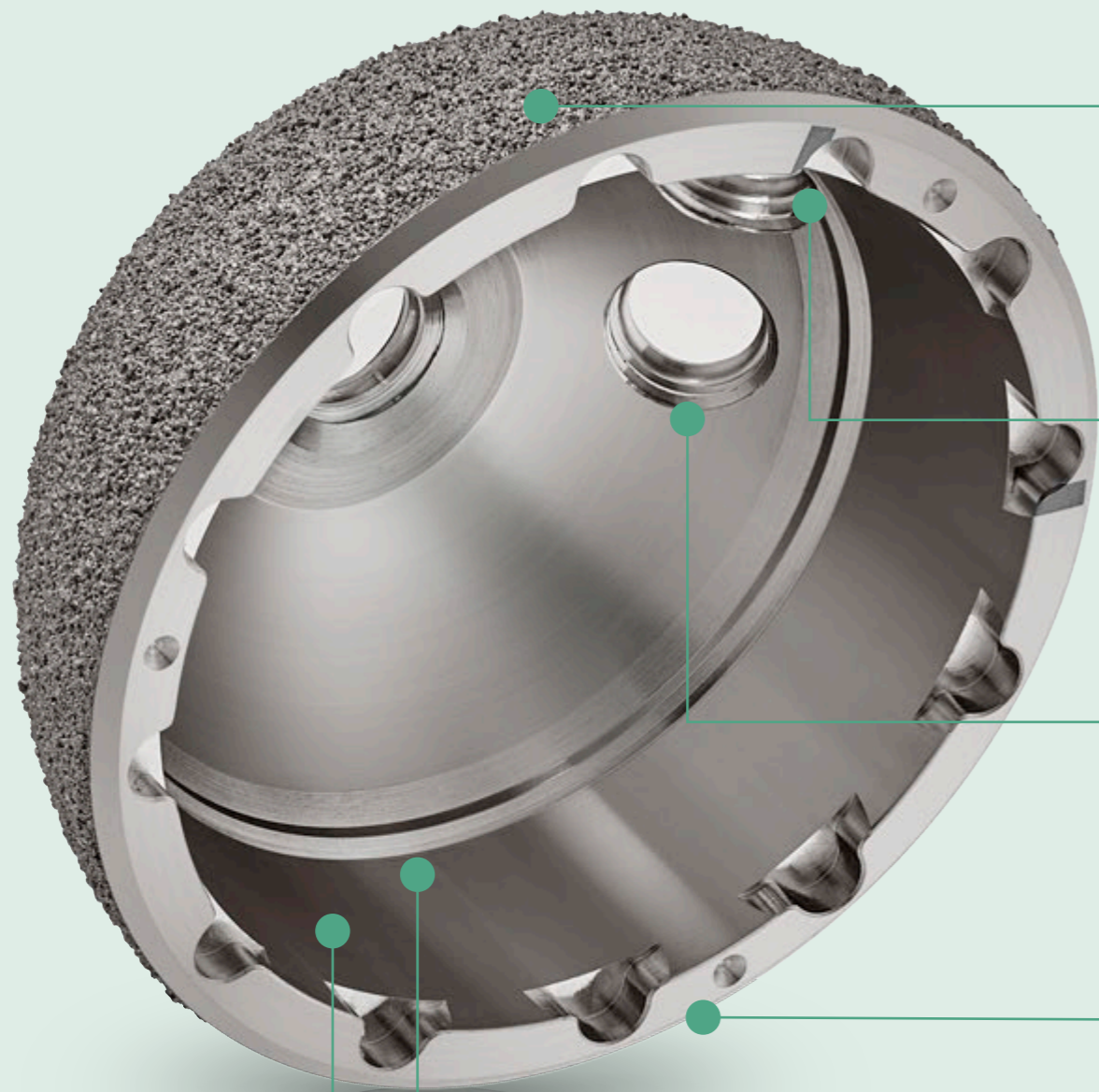

Titanium Plasma Spray PLUS (TPS PLUS) with and without Hydroxyapatite (HA) Coating

- Designed to improve biological fixation

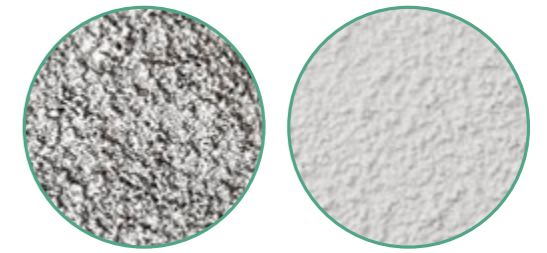

Laser Mark

- Helps provide surgeons with an identifying marker for screw hole locations

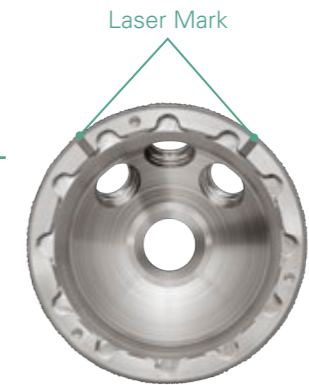

Multi-angle Screw Hole

- Designed to allow optimized screw angulation

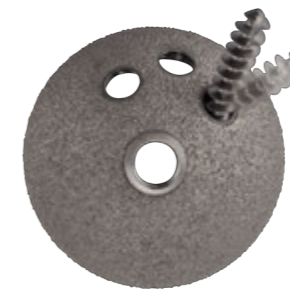

Multiple Cup Configurations

- No-hole, cluster-hole and multi-hole cup configuration are available from 44 mm to 70 mm



Locking Ring for Poly Liner Locking

-The inner locking ring on the acetabular cup provide the superior locking strength for polyethylene liner

Taper for Ceramic Liner Locking

-The taper located on the inner wall of acetabular cup is designed to provide superior locking strength for the ceramic liner

- The universal locking mechanism of U-Motion II PLUS acetabular cup can be used with polyethylene and ceramic liner

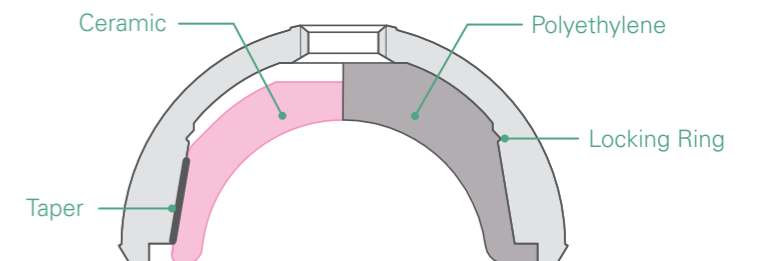

Various Bearing Options

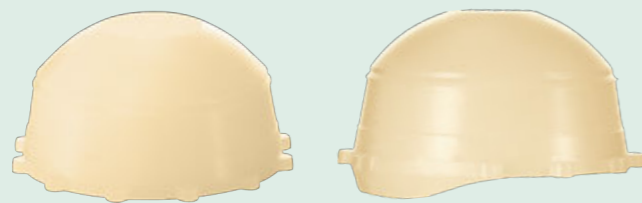

Standard and 20° Lipped Liners

- Available in XPE and E-XPE material

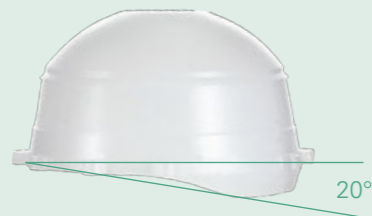

20° Lipped

- Designed to provide additional stability



Crown Tab

Crown Tab on the 20° Lipped Liner

- Three tabs indicate the orientation of 20° lip

Two Femoral Head Material Are Available

- Cobalt Chrome (CoCr)
- BIOLOX® *delta*

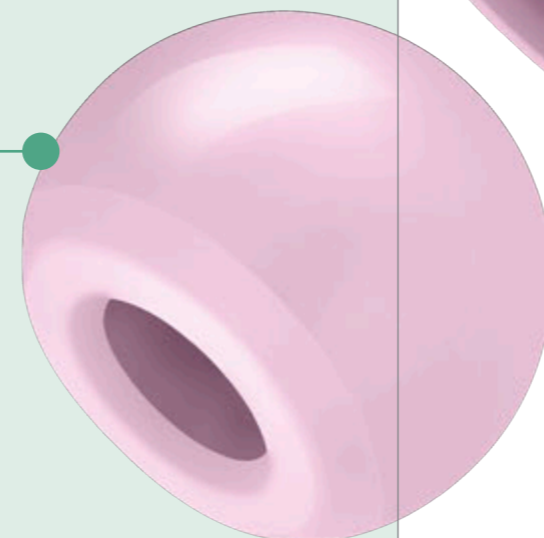

Anti-rotational Tabs

- Designed to provide the anti-rotation

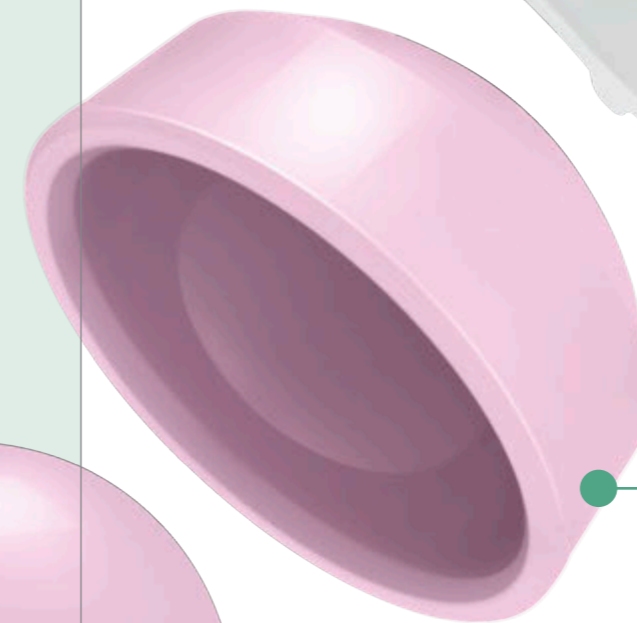

Three Liner Material Are Available

- XPE (Highly Crosslinked Polyethylene)
- E-XPE (Vitamin E Highly Crosslinked Polyethylene)
- BIOLOX® *delta*

E-XPE

Vitamin E Highly Crosslinked Polyethylene



Advanced Bearing Technology

Wear Performance

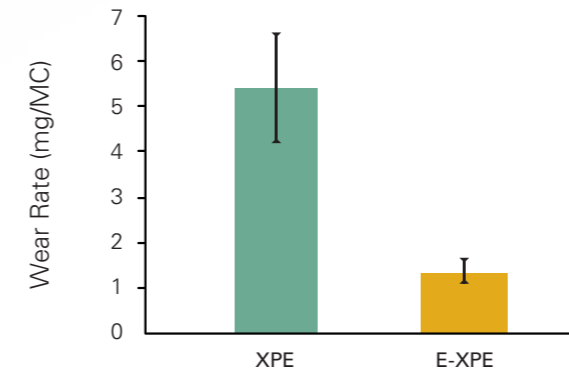

Extraordinary Wear Performance

E-XPE liner shows 75% reduction in gravimetric wear compared to XPE after accelerated aging^[3].

Mechanical Strength

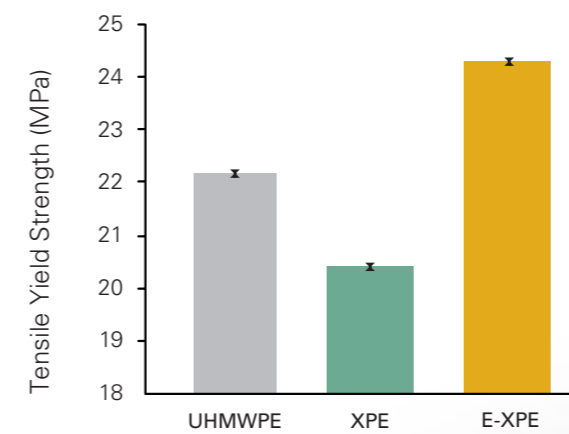

Enhanced Mechanical Strength

Heat treatment is not required after cross-linking process. Therefore, E-XPE shows a 20% tensile strength improvement as compared to highly cross-linked polyethylene^[4].

Oxidative Stability

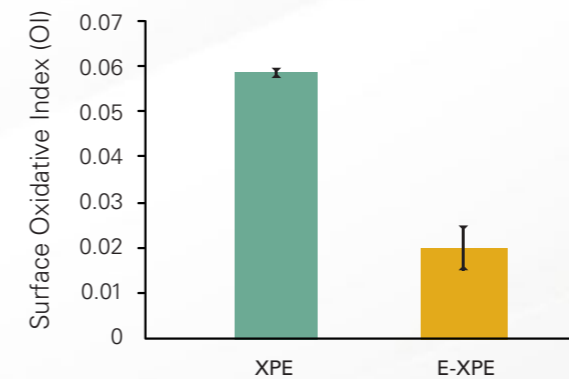

Superior Oxidative Stability

Surface oxidative index of E-XPE shows significant low oxidation after in vitro accelerated aging test^[5].

Wide Range of Motion

Large head combined with 12/14 stem taper, increasing range of motion and delaying impingement.



Cup Size	Head Size	Liner	Flexion/ Extension	I/E Rotation	ABD-ADD
46 mm	Ø28 mm	0°	173°	198°	120°
50 mm	Ø32 mm	0°	192°	222°	133°
54 mm	Ø36 mm	0°	197°	229°	137°

Range of motion tested with a UTF reduced stem in accordance with ISO 21535 standard for a physiologically positioned cup and stem.

Quick Compatibility Guide

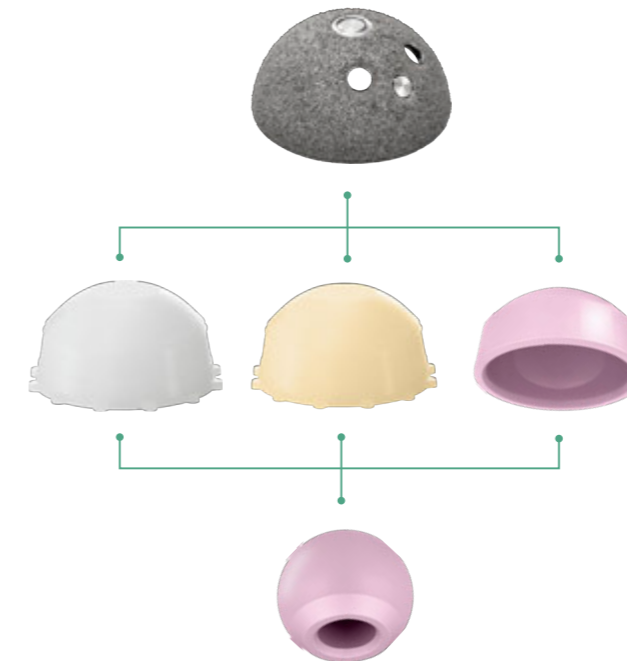

Ceramic Head with E-XPE, XPE and Ceramic Liner

Cup Size (mm)	Ceramic Head Size (mm)			
44	28			
46				
48		32		
50				
52			36	
54				
56			36 (poly liner only)	40
58				
60				
62				
64				
66				
68				
70				

CoCr Head with E-XPE and XPE liner

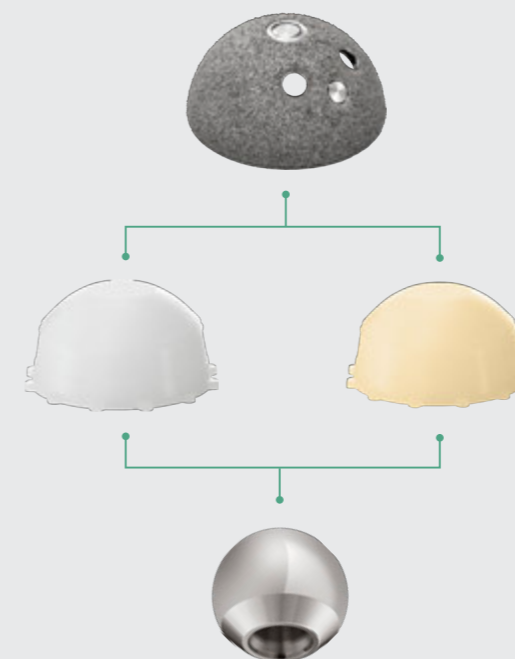

Cup Size (mm)	CoCr Head Size (mm)		
44	28		
46			
48		32	
50			
52			36
54			
56			
58			
60			
62			
64			
66			
68			
70			

Order Information

Compatibility Guide for Polyethylene Liner (E-XPE, XPE) and CoCr Head

* Special Order Items



Cup	Coating	Outer Diameter (mm)													
		44	46	48	50	52	54	56	58	60	62	64*	66*	68*	70*
Cluster-Hole	TPS PLUS	1306-3144	1306-3146	1306-3148	1306-3150	1306-3152	1306-3154	1306-3156	1306-3158	1306-3160	1306-3162	1306-3164	1306-3166	1306-3168	1306-3170
	TPS PLUS with HA	1306-1144	1306-1146	1306-1148	1306-1150	1306-1152	1306-1154	1306-1156	1306-1158	1306-1160	1306-1162	1306-1164	1306-1166	1306-1168	1306-1170
No-Hole	TPS PLUS	1306-3344	1306-3346	1306-3348	1306-3350	1306-3352	1306-3354	1306-3356	1306-3358	1306-3360	1306-3362	1306-3364	1306-3366	1306-3368	1306-3370
Multi-Hole	TPS PLUS with HA	1306-1544	1306-1546	1306-1548	1306-1550	1306-1552	1306-1554	1306-1556	1306-1558	1306-1560	1306-1562	1306-1564	1306-1566	1306-1568	1306-1570

Liner	Lipped	Inner Diameter (mm)													
		28		32		36									
XPE	0°	1406-3844	1406-3846	1406-3248	1406-3250	1406-3652	1406-3654	1406-3656	1406-3658	1406-3660	1406-3662	1406-3664	1406-3666	1406-3668	1406-3670
	20°	1406-5844	1406-5846	1406-5248	1406-5250	1406-5652	1406-5654	1406-5656	1406-5658	1406-5660	1406-5662	1406-5664	1406-5666	1406-5668	1406-5670
E-XPE	0°	1406-7144	1406-7146	1406-7248	1406-7250	1406-7352	1406-7354	1406-7356	1406-7358	1406-7360	1406-7362	1406-7364	1406-7366	1406-7368	1406-7370
	20°	1406-7544	1406-7546	1406-7648	1406-7650	1406-7752	1406-7754	1406-7756	1406-7758	1406-7760	1406-7762	1406-7764	1406-7766	1406-7768	1406-7770

Femoral Head	Diameter (mm)		
	28	32	36
CoCr	1206-1028 (-3)	1206-1032 (-3)	1206-1036 (-3)
	1206-1128 (+0)	1206-1132 (+0)	1206-1136 (+0)
	1206-1228 (+2.5)	1206-1232 (+2.5)	1206-1236 (+2.5)
	1206-1428 (+5)	1206-1432 (+5)	1206-1436 (+5)
	1206-1628 (+7.5)	1206-1632 (+7.5)	1206-1636 (+7.5)
	1206-1828 (+10)	1206-1832 (+10)	1206-1836 (+10)

Special Specification Items:

- 40 mm Cup compatible with 22 mm diameter femoral head
- 42 mm Cup compatible with 28 mm diameter femoral head
- 46 mm Cup compatible with 32 mm diameter femoral head
- 48 mm Cup compatible with 36 mm diameter femoral head
- 50 mm Cup compatible with 36 mm diameter femoral head
- 54 mm Cup compatible with 40 mm diameter femoral head
- 52-70 mm Cup compatible with 32 mm diameter femoral head

The special specification items are only sold in certain area, please contact with local distributor for further information.

Order Information

Compatibility Guide for Polyethylene Liner (E-XPE, XPE) and Ceramic Head

* Special Order Items



Cup	Coating	Outer Diameter (mm)													
		44	46	48	50	52	54	56	58	60	62	64*	66*	68*	70*
Cluster-Hole	TPS PLUS	1306-3144	1306-3146	1306-3148	1306-3150	1306-3152	1306-3154	1306-3156	1306-3158	1306-3160	1306-3162	1306-3164	1306-3166	1306-3168	1306-3170
	TPS PLUS with HA	1306-1144	1306-1146	1306-1148	1306-1150	1306-1152	1306-1154	1306-1156	1306-1158	1306-1160	1306-1162	1306-1164	1306-1166	1306-1168	1306-1170
No-Hole	TPS PLUS	1306-3344	1306-3346	1306-3348	1306-3350	1306-3352	1306-3354	1306-3356	1306-3358	1306-3360	1306-3362	1306-3364	1306-3366	1306-3368	1306-3370
Multi-Hole	TPS PLUS with HA	1306-1544	1306-1546	1306-1548	1306-1550	1306-1552	1306-1554	1306-1556	1306-1558	1306-1560	1306-1562	1306-1564	1306-1566	1306-1568	1306-1570

Liner	Lipped	Inner Diameter (mm)													
		28		32		36		40							
XPE	0°	1406-3844	1406-3846	1406-3248	1406-3250	1406-3652	1406-3654	1406-3056	1406-3058	1406-3060	1406-3062	1406-3064	1406-3066	1406-3068	1406-3070
	20°	1406-5844	1406-5846	1406-5248	1406-5250	1406-5652	1406-5654	1406-5056	1406-5058	1406-5060	1406-5062	1406-5064	1406-5066	1406-5068	1406-5070
E-XPE	0°	1406-7144	1406-7146	1406-7248	1406-7250	1406-7352	1406-7354	1406-7456	1406-7458	1406-7460	1406-7462	1406-7464	1406-7466	1406-7468	1406-7470
	20°	1406-7544	1406-7546	1406-7648	1406-7650	1406-7752	1406-7754	1406-7856	1406-7858	1406-7860	1406-7862	1406-7864	1406-7866	1406-7868	1406-7870

Femoral Head	Diameter (mm)			
	28	32	36	40
BIOLOX® delta	1203-5028 S (-2.5)	1203-5032 S (-3)	1203-5036 S (-3)	1203-5040 S (-3)
	1203-5228 M (+1)	1203-5232 M (+1)	1203-5236 M (+1)	1203-5240 M (+1)
	1203-5428 L (+4)	1203-5432 L (+5)	1203-5436 L (+5)	1203-5440 L (+5)
		1203-5632 XL (+8)	1203-5636 XL (+9)	1203-5640 XL (+9)

Special Specification Items:

- 40 mm Cup compatible with 22 mm diameter femoral head
- 42 mm Cup compatible with 28 mm diameter femoral head
- 46 mm Cup compatible with 32 mm diameter femoral head
- 48 mm Cup compatible with 36 mm diameter femoral head
- 50 mm Cup compatible with 36 mm diameter femoral head
- 54 mm Cup compatible with 40 mm diameter femoral head
- 52-70 mm Cup compatible with 32 mm diameter femoral head

The special specification items are only sold in certain area, please contact with local distributor for further information.

Order Information

Compatibility Guide for Ceramic Liner and Ceramic Head

* Special Order Items



Cup	Coating	Outer Diameter (mm)													
		44	46	48	50	52	54	56	58	60	62	64*	66*	68*	70*
Cluster-Hole	TPS PLUS	1306-3144	1306-3146	1306-3148	1306-3150	1306-3152	1306-3154	1306-3156	1306-3158	1306-3160	1306-3162	1306-3164	1306-3166	1306-3168	1306-3170
	TPS PLUS with HA	1306-1144	1306-1146	1306-1148	1306-1150	1306-1152	1306-1154	1306-1156	1306-1158	1306-1160	1306-1162	1306-1164	1306-1166	1306-1168	1306-1170
No Hole	TPS PLUS	1306-3344	1306-3346	1306-3348	1306-3350	1306-3352	1306-3354	1306-3356	1306-3358	1306-3360	1306-3362	1306-3364	1306-3366	1306-3368	1306-3370
Multi-Hole	TPS PLUS with HA	1306-1544	1306-1546	1306-1548	1306-1550	1306-1552	1306-1554	1306-1556	1306-1558	1306-1560	1306-1562	1306-1564	1306-1566	1306-1568	1306-1570

Liner	Inner Diameter (mm)			
	28	32	36	40
BIOLOX® delta	1406-1844	1406-1248	1406-1652	1406-1056 1406-1064

Femoral Head	Diameter (mm)			
	28	32	36	40
BIOLOX® delta	1203-5028 S (-2.5)	1203-5032 S (-3)	1203-5036 S (-3)	1203-5040 S (-3)
	1203-5228 M (+1)	1203-5232 M (+1)	1203-5236 M (+1)	1203-5240 M (+1)
	1203-5428 L (+4)	1203-5432 L (+5)	1203-5436 L (+5)	1203-5440 L (+5)
		1203-5632 XL (+8)	1203-5636 XL (+9)	1203-5640 XL (+9)

Special Specification Items:

- 40 mm Cup compatible with 22 mm diameter femoral head
- 42 mm Cup compatible with 28 mm diameter femoral head
- 46 mm Cup compatible with 32 mm diameter femoral head
- 48 mm Cup compatible with 36 mm diameter femoral head
- 50 mm Cup compatible with 36 mm diameter femoral head
- 54 mm Cup compatible with 40 mm diameter femoral head
- 52-70 mm Cup compatible with 32 mm diameter femoral head

The special specification items are only sold in certain area, please contact with local distributor for further information.

* Special Order Items

Order Information

	Catalog Number	Length
Ti Cancellous Screw, Ø 6.5 mm 	5206 - 1015	15 mm
	5206 - 1020	20 mm
	5206 - 1025	25 mm
	5206 - 1030	30 mm
	5206 - 1035	35 mm
	5206 - 1040	40 mm
	5206 - 1045	45 mm*
	5206 - 1050	50 mm*

Screw Hole Covers



1306 - 1001

Reference

[1] Jasty M et al. *In vivo skeletal responses to porous-surfaced implants subjected to small induced motions.* J Bone Joint Surg Am. 1997 May;79(5):707-14.

[2] Feighan JE et al. *The influence of surface-blasting on the incorporation of titanium-alloy implants in a rabbit intramedullary model.* J Bone Joint Surg Am. 1995 Sep;77(9):1380-95.

[3] Data held on file. United Orthopedic Corporation

[4] Data held on file. United Orthopedic Corporation

[5] Data held on file. United Orthopedic Corporation

Please note that all United Orthopedic Corporation product brochures have been authored in the English language. Any translations into other languages have not been reviewed or approved by United Orthopedic Corporation and their accuracy cannot be confirmed. Any questions regarding United Orthopedic Corporation products should be directed to United Orthopedic Corporation at unitedorthopedic.com/contact.

The CE mark is valid only if it is also printed on the product label.



Importiert & vertrieben in der Schweiz durch
Importé & distribué en Suisse par
Importato e distribuito in Svizzera da

 **PLUSORTHO**
PROTHETIK

Aeschwahrstrasse 54 info.ch@plusortho.ch
CH-4665 Oftringen tel +41(0)62 788 2010
www.plusortho.ch fax +41(0)62 788 2011

